

## SMT MEDIUM POWER GaAs MMIC AMPLIFIER, 25.5 - 33.5 GHz

### Typical Applications

This amplifier is ideal for use as a power amplifier for 25.5 - 33.5 GHz applications:

- LMDS
- Microwave Radio

### Features

- SMT mmWave Package
- Gain > 15 dB
- Broadband Performance
- Saturated Output Power: +24 dBm
- Positive Supply: +5V to +7V

### Functional Diagram

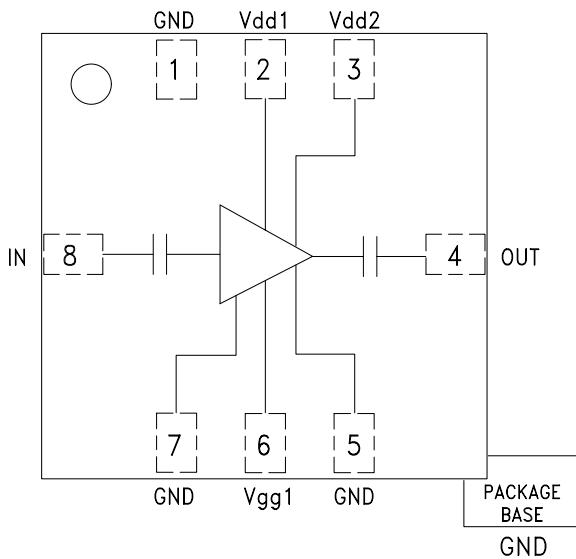

### General Description

The HMC300LM1 is a broadband surface mount medium power amplifier that operates between 25.5 and 33.5 GHz. A 0.25 um power pHEMT process is used to achieve efficient gain and output power performance. High volume surface mount re-flow assembly techniques may be used to mount the amplifier to the end user's PCB. The LM1 package eliminates the need for wire bonding or die attach mounting. The amplifier provides 15 dB of gain and +24 dBm of saturated output power across various microwave radio bands. This millimeter wave amplifier requires no external RF matching components and minimal DC bypass components. The amplifier operates from a +6V Vdd and a -0.35V Vgg gate bias.

### Electrical Specifications, $T_A = +25^\circ C, V_{dd} = +6V$

Parameter	Min.	Typ.	Max.	Units
Frequency Range	25.5 - 33.5			GHz
Gain	13	16	22	dB
Gain Variation Over Temperature		0.06	0.07	dB/°C
Input Return Loss	5	8		dB
Output Return Loss	5	8		dB
Reverse Isolation	35	50		dB
Output 1 dB Compression (P1dB)	20	23		dBm
Saturated Output Power (Psat)	21	24		dBm
Output Third Order Intercept (IP3) (Two-tone Input Power = -5 dBm each tone)	21	26		dBm
Supply Current (Idd)(Vdd = +6.0 Vdc)*		220	275	mA

\*Adjust Vgg 1 between -1.0 to 0V to achieve Idd = 220 mA typical.

## SMT MEDIUM POWER GaAs MMIC AMPLIFIER, 25.5 - 33.5 GHz

**Broadband Gain & Return Loss**

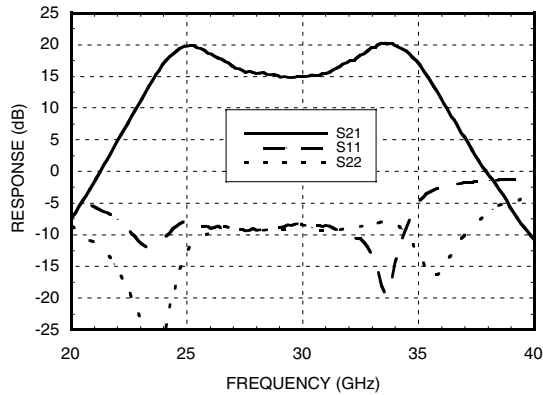

**Gain vs. Temperature @ Vdd = +6V**

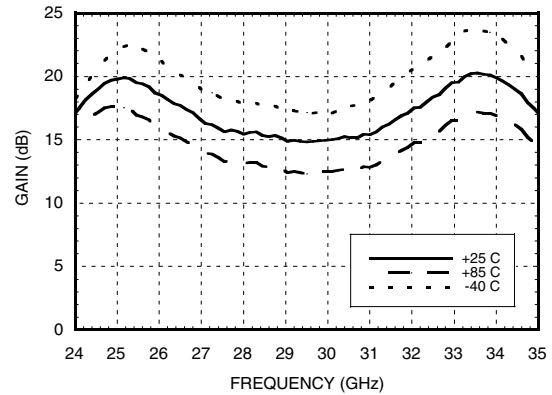

**Input Return Loss vs. Temperature @ Vdd = +6V**

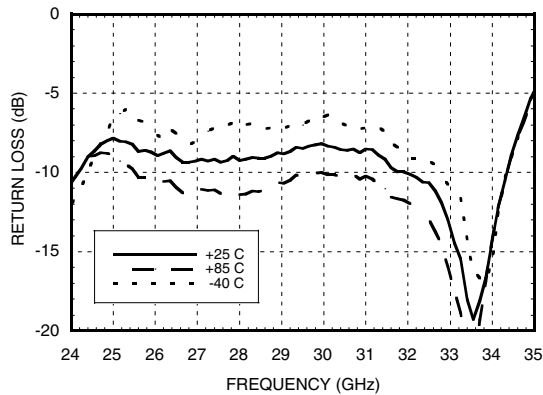

**Output Return Loss vs. Temperature @ Vdd = +6V**

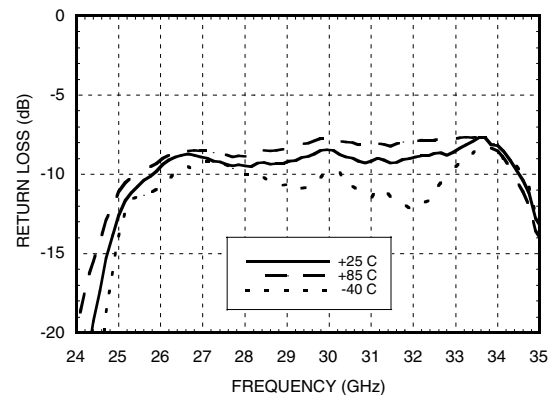

**P1dB Output Power vs. Temperature @ Vdd = +6V**

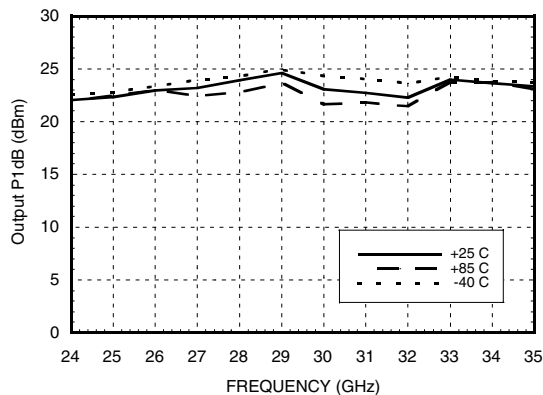

**Output IP3 vs. Temperature @ Vdd = +6V**

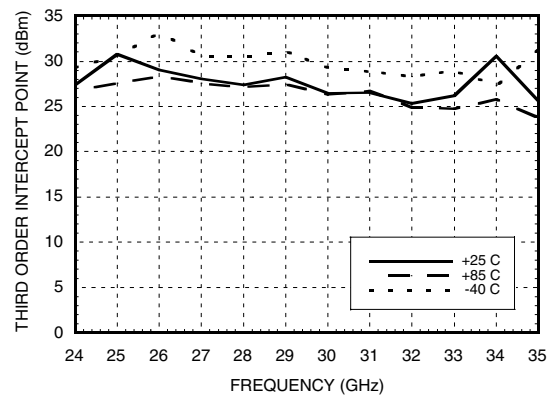

## SMT MEDIUM POWER GaAs MMIC AMPLIFIER, 25.5 - 33.5 GHz

**Gain vs. Vdd**

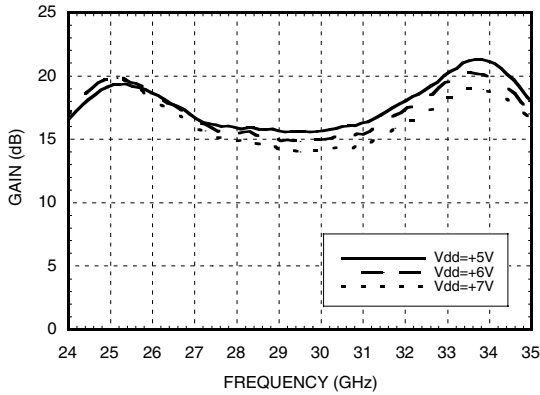

**Input Return Loss vs. Vdd**

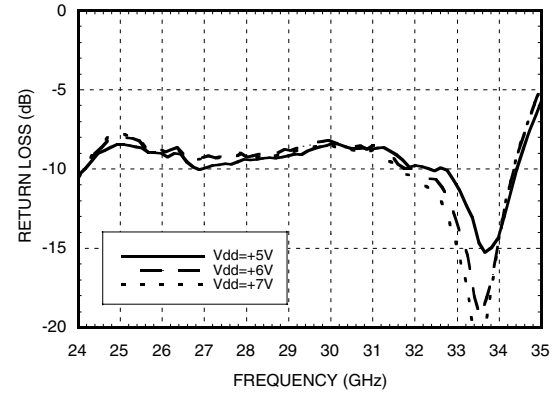

**Output Return Loss vs. Vdd**

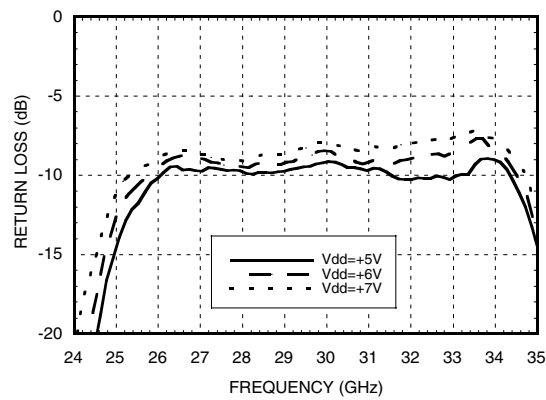

**P1dB Output Power vs. Vdd**

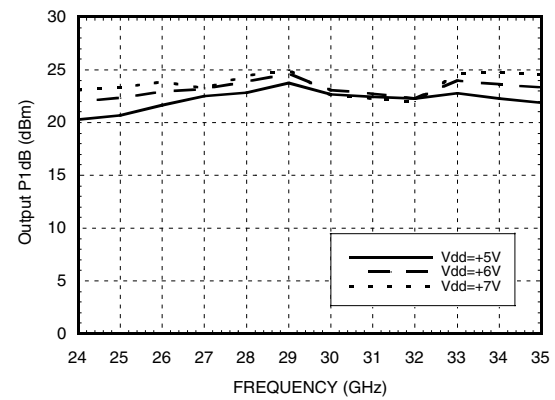

**PSAT Output Power vs. Vdd**

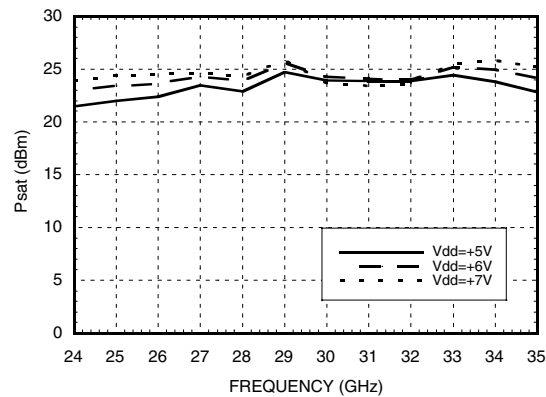

**IP3 vs. Vdd**

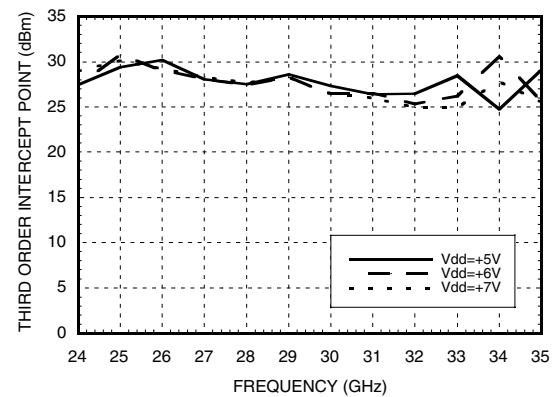

## SMT MEDIUM POWER GaAs MMIC AMPLIFIER, 25.5 - 33.5 GHz

### Absolute Maximum Ratings

Drain Bias Voltage (Vdd1, Vdd2)	+5.0 Vdc
Drain Bias Current (Idd)	500 mA
Gate Bias Voltage (Vgg1)	-2.0 to +0.4 Vdc
RF Input Power (RFIn)(Vdd = +6.0 Vdc)	+10 dBm
Channel Temperature	150 °C
Continuous Pdiss (T = 85 °C) (derate 15.03 mW/°C above 85 °C)	0.977 W
Thermal Resistance (channel to ground paddle)	67 °C/W
Storage Temperature	-65 to +150 °C
Operating Temperature	-40 to +85°C

### Outline Drawing

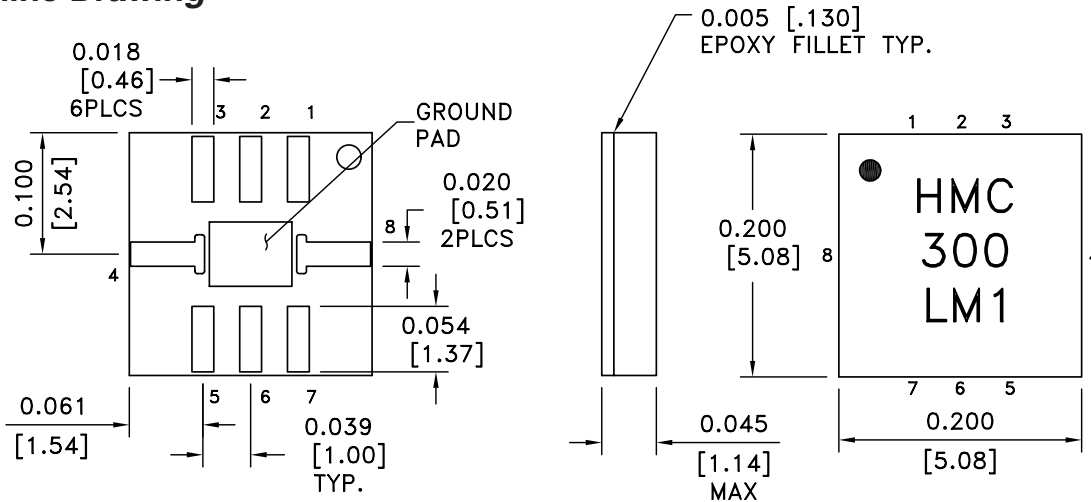

Pin	Function
1	GND
2	Vdd1
3	Vdd2
4	RF OUT
5	GND
6	Vgg1
7	GND
8	RF IN

NOTES:

1. MATERIAL: PLASTIC
2. PLATING: GOLD OVER NICKEL
3. DIMENSIONS ARE IN INCHES [MILLIMETERS].
4. ALL TOLERANCES ARE ± 0.005 [± 0.13].
5. ALL GROUNDS MUST BE SOLDERED TO PCB RF GROUND.
6. ● INDICATES PIN 1

## SMT MEDIUM POWER GaAs MMIC AMPLIFIER, 25.5 - 33.5 GHz

### Evaluation PCB

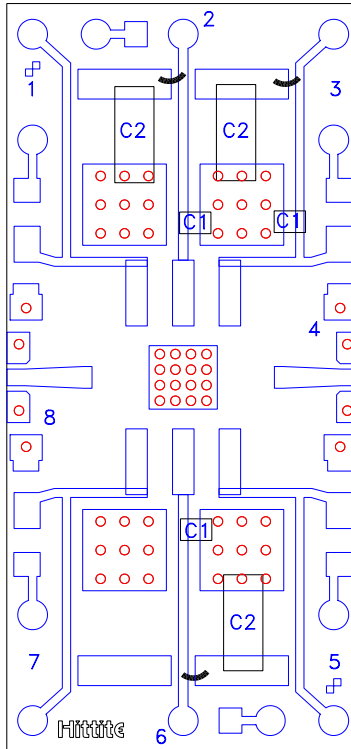

The grounded Co-Planar Wave Guide (CPWG) PCB input/output transitions allow use of Ground-Signal-Ground (GSG) probes for testing. Suggested probe pitch is 400µm (16 mils). Alternatively, the board can be mounted in a metal housing with 2.4 mm coaxial connectors.

### Evaluation Circuit Board Layout Design Details

Layout Technique	Micro Strip to CPWG
Material	Rogers 4003 with 1/2 oz. Cu
Dielectric Thickness	0.008" (0.20 mm)
Microstrip Line Width	0.018" (0.46 mm)
CPWG Line Width	0.016" (0.41 mm)
CPWG Line to GND Gap	0.005" (0.13 mm)
Ground Via Hole Diameter	0.008" (0.20 mm)
C1	100 pF Capacitor, 0402 Pkg.
C2	33,000 pF Capacitor, 1206 Pkg.

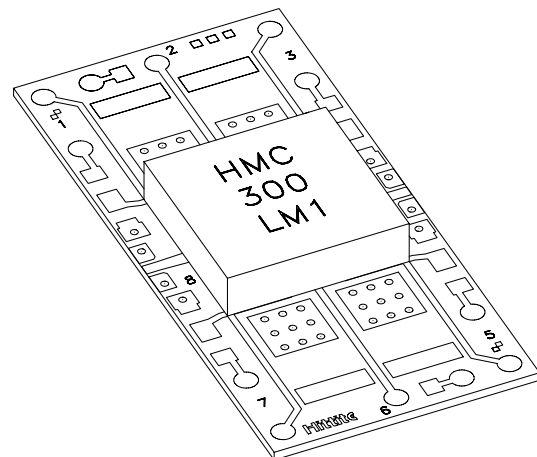

**LM1 Package Mounted to Evaluation PCB**

## SMT MEDIUM POWER GaAs MMIC AMPLIFIER, 25.5 - 33.5 GHz

**Suggested LM1 PCB Land Pattern** Tolerance:  $\pm 0.003''$  ( $\pm 0.08$  mm)

UPDATED 12-5-01

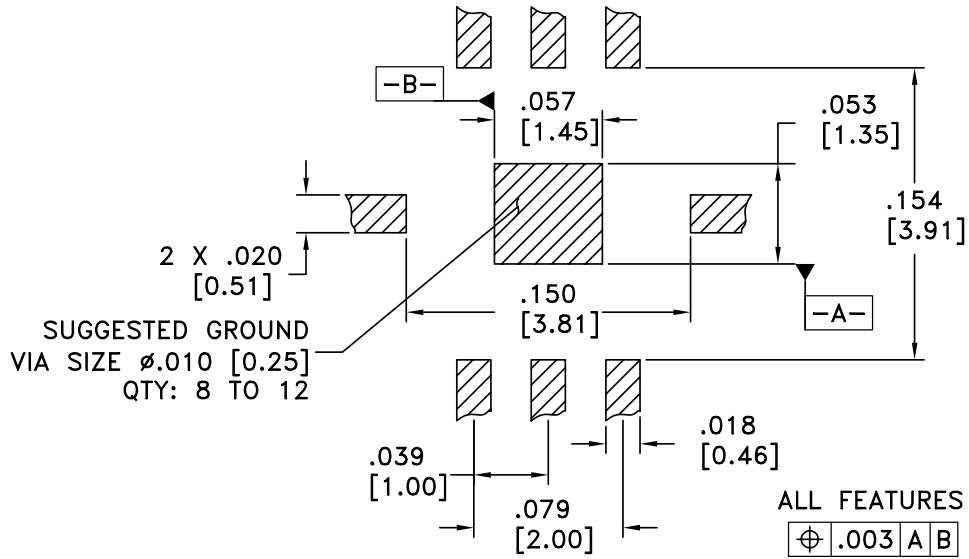

## SMT MEDIUM POWER GaAs MMIC AMPLIFIER, 25.5 - 33.5 GHz

### Application Circuit

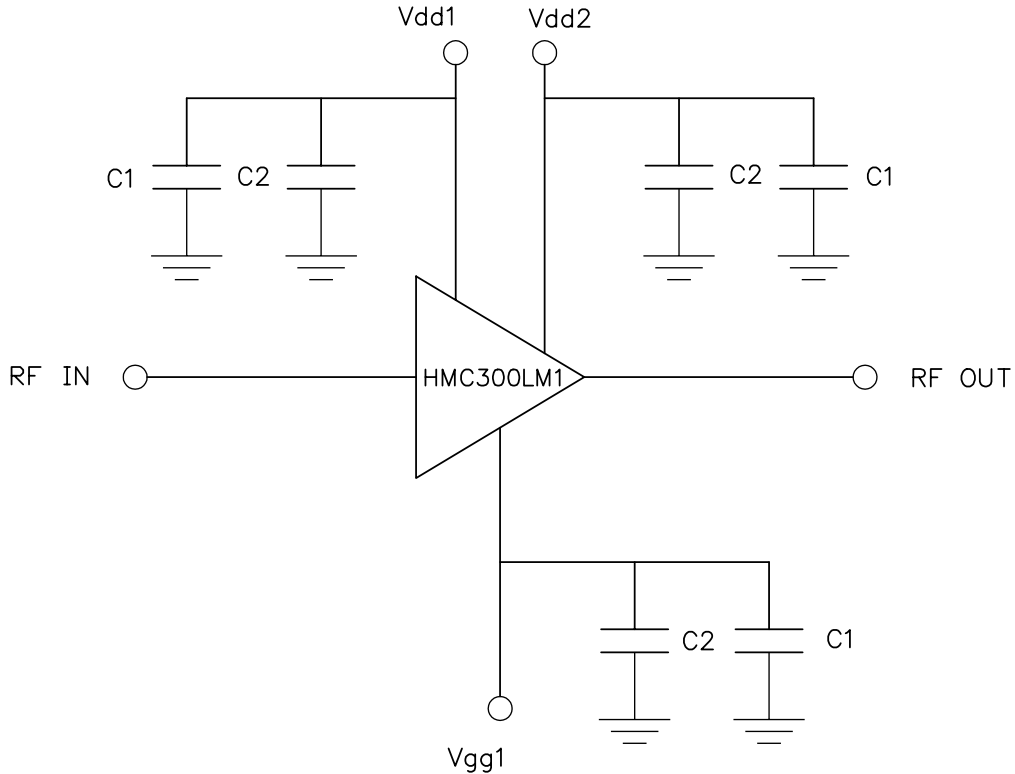

Recommended Component Values	
C1	100 pF
C2	33,000 pF

**Note:**

*Vgg1 should be applied to Pin 6 to provide appropriate bias level to Amplifier. Voltage level should be adjusted until nominal I<sub>dd</sub> of 220 mA is reached.*

**SMT MEDIUM POWER GaAs MMIC  
AMPLIFIER, 25.5 - 33.5 GHz****Recommended SMT Attachment Technique****Preparation & Handling of the LM1 Millimeterwave Package for Surface Mounting**

The HMC LM1 package was designed to be compatible with high volume surface mount PCB assembly processes. The LM1 package requires a specific mounting pattern to allow proper mechanical attachment and to optimize electrical performance at millimeterwave frequencies. This PCB layout pattern can be found on each LM1 product data sheet. It can also be provided as an electronic drawing upon request from Hittite Sales & Application Engineering.

Follow these precautions to avoid permanent damage:

**Cleanliness:** Observe proper handling procedures to ensure clean devices and PCBs. LM1 devices should remain in their original packaging until component placement to ensure no contamination or damage to RF, DC & ground contact areas.

**Static Sensitivity:** Follow ESD precautions to protect against ESD strikes.

**General Handling:** Handle the LM1 package on the top with a

vacuum collet or along the edges with a sharp pair of bent tweezers. Avoid damaging the RF, DC, & ground contacts on the package bottom. Do not apply excess pressure to the top of the lid.

**Solder Materials & Temperature Profile:** Follow the information contained in the application note. Hand soldering is not recommended. Conductive epoxy attachment is not recommended.

**Solder Paste**

Solder paste should be selected based on the user's experience and should be compatible with the metallization systems used. See the LM1 data sheet Outline drawing for pin & ground contact metallization schemes.

**Solder Paste Application**

Solder paste is generally applied to the PCB using either a stencil printer or dot placement. The volume of solder paste will be dependent on PCB and component layout and should be controlled to ensure consistent mechanical & electrical performance. Excess solder may create unwanted electrical parasitics at high frequencies.

**Solder Reflow**

The soldering process is usually accomplished in a reflow oven but may also use a vapor phase process. A solder reflow profile is suggested above.

Prior to reflowing product, temperature profiles should be measured using the same mass as the actual assemblies. The thermocouple should be moved to various positions on the board to account for edge and corner effects and varying component masses. The final profile should be determined by mounting the thermocouple to the PCB at the location of the device.

Follow solder paste and oven vendor's recommendations when developing a solder reflow profile. A standard profile will have a steady ramp up from room temperature to the pre-heat temperature to avoid damage due to thermal shock. Allow enough time between reaching pre-heat temperature and reflow for the solvent in the paste to evaporate and the flux to completely activate. Reflow must then occur prior to the flux being completely driven off. The duration of peak reflow temperature should not exceed 15 seconds. Packages have been qualified to withstand a peak temperature of 235°C for 15 seconds. Verify that the profile will not expose device to temperatures in excess of 235°C.

**Cleaning**

A water-based flux wash may be used.

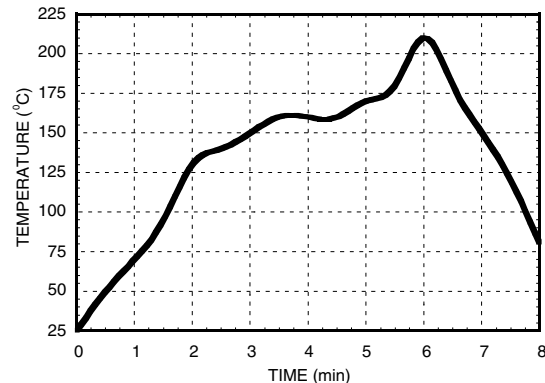

**Recommended solder reflow profile  
for HMC LM1 SMT Package**